



GIGABIT COLOR IP PHONE



USER GUIDE

UC842

Version:1.0.3.59

Notices Information

Copyright

Copyright © 2005 - 2013 Nanjing Hanlong Technology CO., LTD. All rights reserved.

Nanjing Hanlong Technology Co., LTD. owns all the right to revise and change this document at any time. And all the illustrations and instructions in this paper are subject to the copyright protection of legal law. No parts of this document may be used or reproduced, transmitted by the third parties for any purposes without the express written permission of Nanjing Hanlong Technology Co., LTD.

When this document is made available on Hanlong's web page, hanlong Technology Co., LTD. gives its right to download and print copies of this content only for private use as a user manual. No parts shall have the right to alter, modify or use as commercial means without the express written permission of Nanjing Hanlong Technology Co., LTD.

Safety cautions

- To use the Phone follow the instructions in this manual.
- To use the power adapter that delivered with the phone. Other power adapters may damage the phone.
- The phone is only for indoor use. And also avoid in high humidity, water and some other liquids.
- Do not use the phone during thunderstorms.
- CE
- FCC

Disposal of the phone



This symbol indicates that the product is classified as electrical orelectronic equipment and should not be disposed of with other commercial or household waste at the end of its working life.

Cleaning

To clean the device, use an anti-static cloth. Please avoid cleaning liquids as they might damage the surface or internal electronics of the phone.

Table of Content

Notices Information	1
Copyright	1
Safety cautions	1
Disposal of the phone.....	1
Cleaning	2
Table of Content	3
Getting Started.....	5
Packing List	5
Phone Installation.....	7
1. Attach the Foot stand.....	7
2. Connect the Handset and optional Headset.....	8
3. Connect the Network and Power.....	9
Initialization	9
Getting Familiar with Your Phone	11
Hardware Components Preview.....	11
Icon Preview	14
Line Key Function Overview.....	16
Basic Features Configuration	18
Web Login.....	18
Administrator Password.....	19
Language.....	20
Time and Date	22
Ring Tone.....	25
Volume	28
Wallpaper	30
Screen Saver.....	31
Directory	32
Basic Call Features.....	36
Place a Call	36
End a Call.....	37
Redial a Call.....	37
Receive a Call	37
Auto Answer	38
Call Hold.....	39
Call Transfer.....	40
Call Conference.....	42
Call Forward	43
Call Return.....	48
Hide Caller ID.....	49

Reject Anonymous	50
Call Mute	51
DND.....	51
Key as Send.....	52
No Key Entry Timeout.....	53
Keypad Lock.....	54
Hot Line	55
Advanced Features.....	57
Voice Message.....	57
Intercom	57
Speed Dial.....	59
Direct Pickup	60
Group Pickup	61
BLF.....	61
Shared Line	63
Record.....	64
Call Park.....	65
Paging	65
DTMF	66
Prefix.....	67
Upgrade	68
Factory Reset	68
Upgrade.....	68
Troubleshooting.....	71
Why is the phone LCD screen blank?.....	71
Why does the phone display "Network Unavailable"?	71
Why can't I get a dial tone?	71

Getting Started

Packing List

The package contains the following parts, please check if all the items are not missed:

1. The phone device

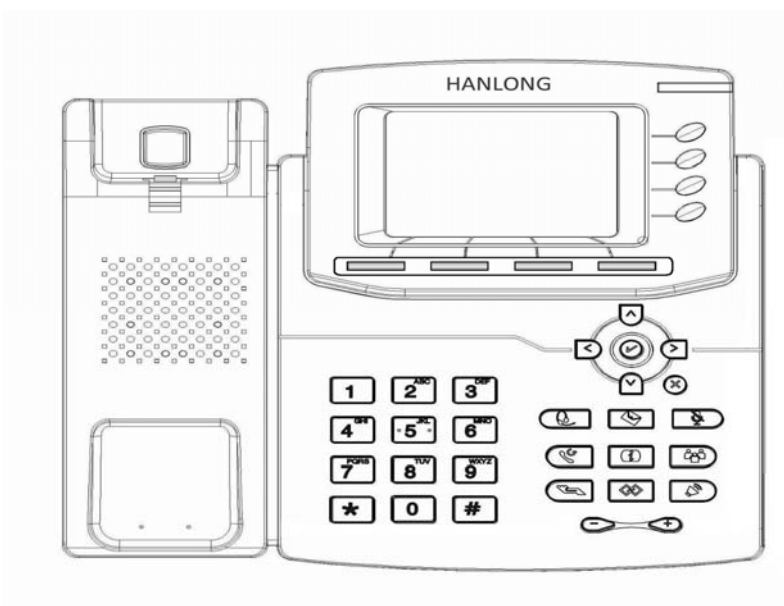

2. The footstand

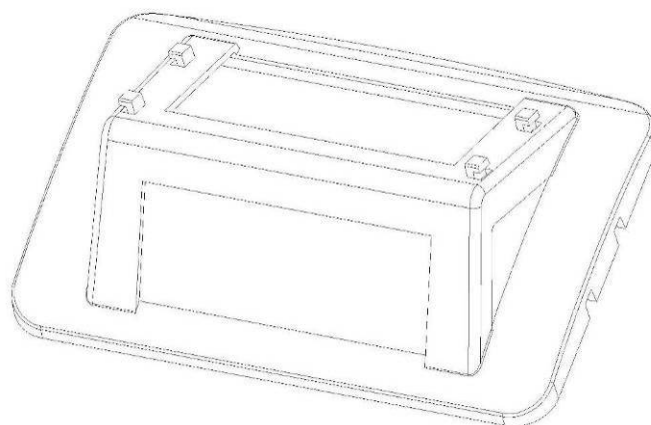

3. Handset



4. Headset cord

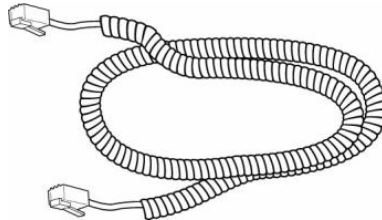

5. Power adapter

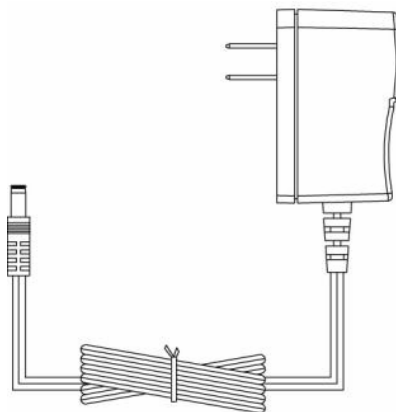

6. Ethernet cable

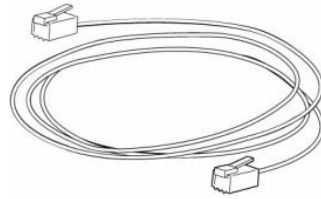

7. Quick installation reference

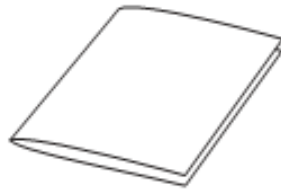

Phone Installation

1. Attach the Foot stand

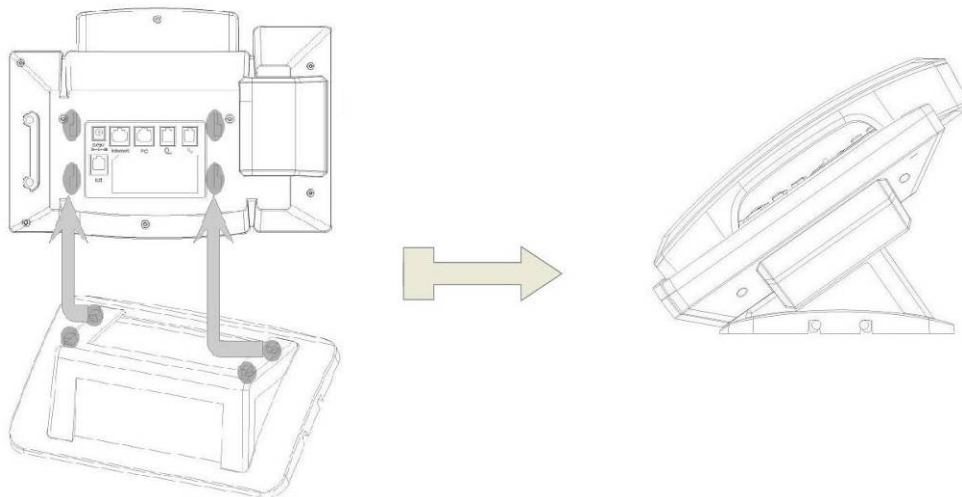

2. Connect the Handset and optional Headset

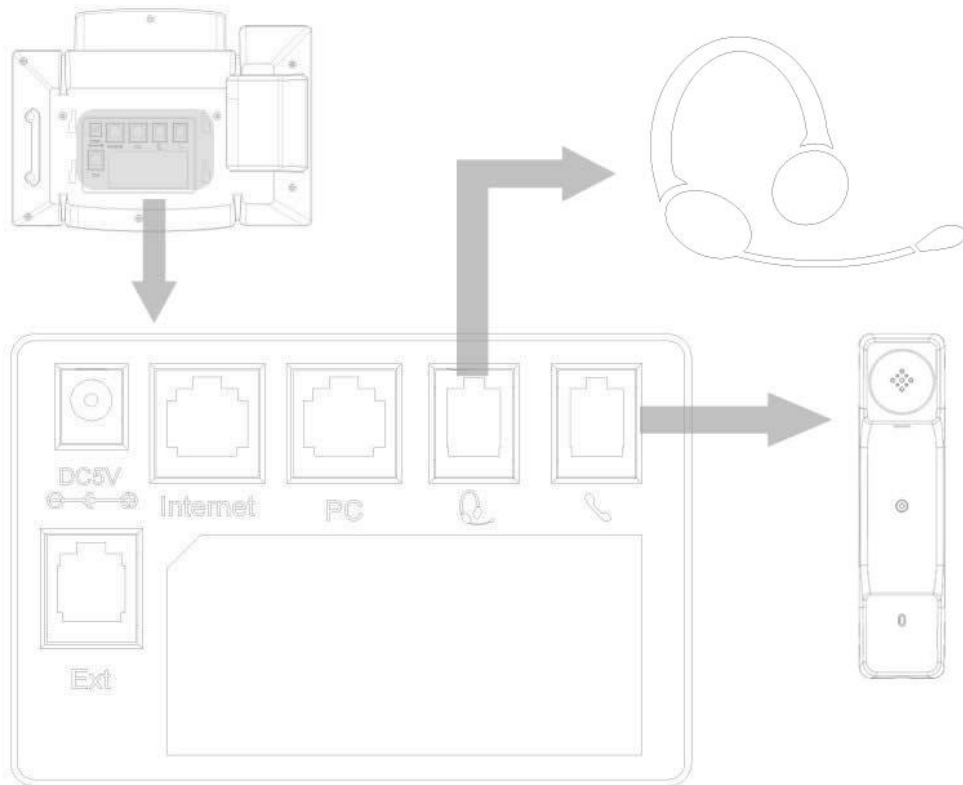

3. Connect the Network and Power

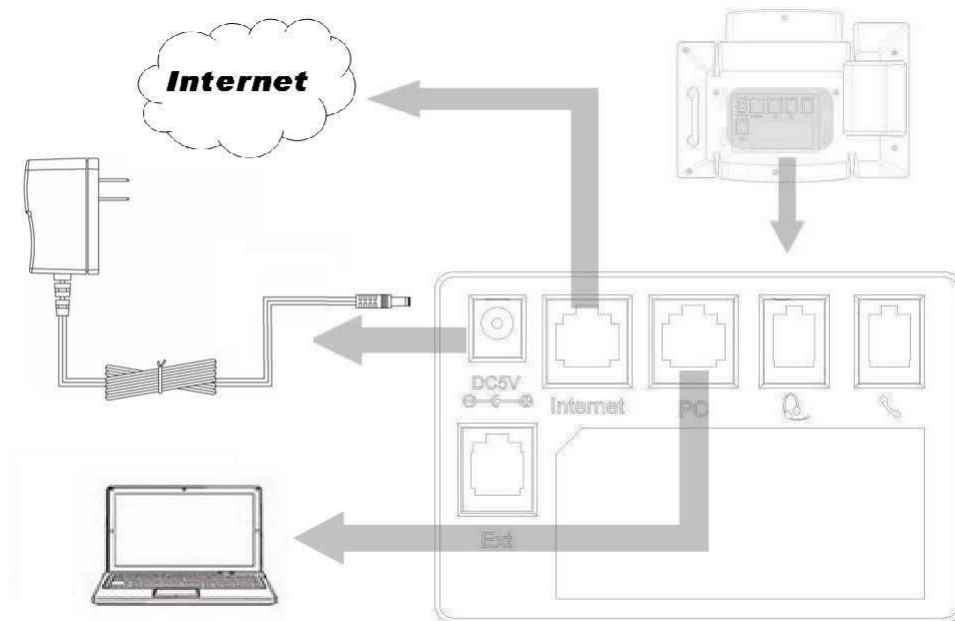

Initialization

After your phone has been powered up, the system boots up and performs the following steps:

Automatic Phone Initialization

The phone finishes the initialization process by loading the saved configuration. The phone LCD screen will display "Booting"

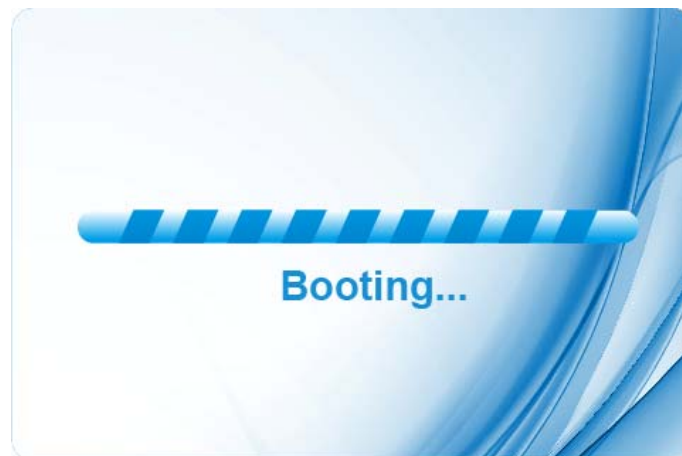

And then show “Initializing “during the initialization.

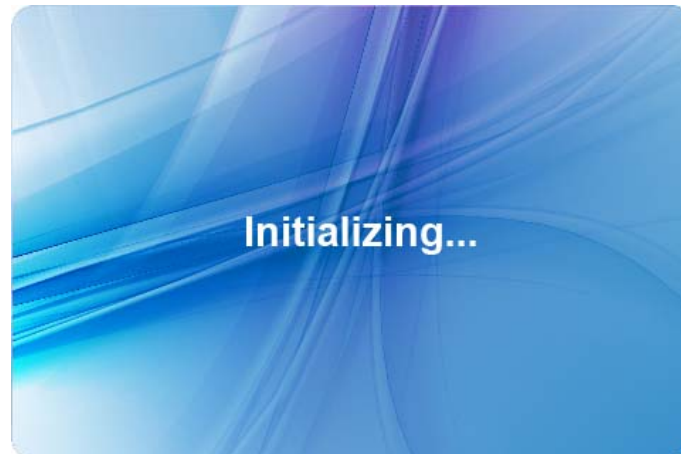







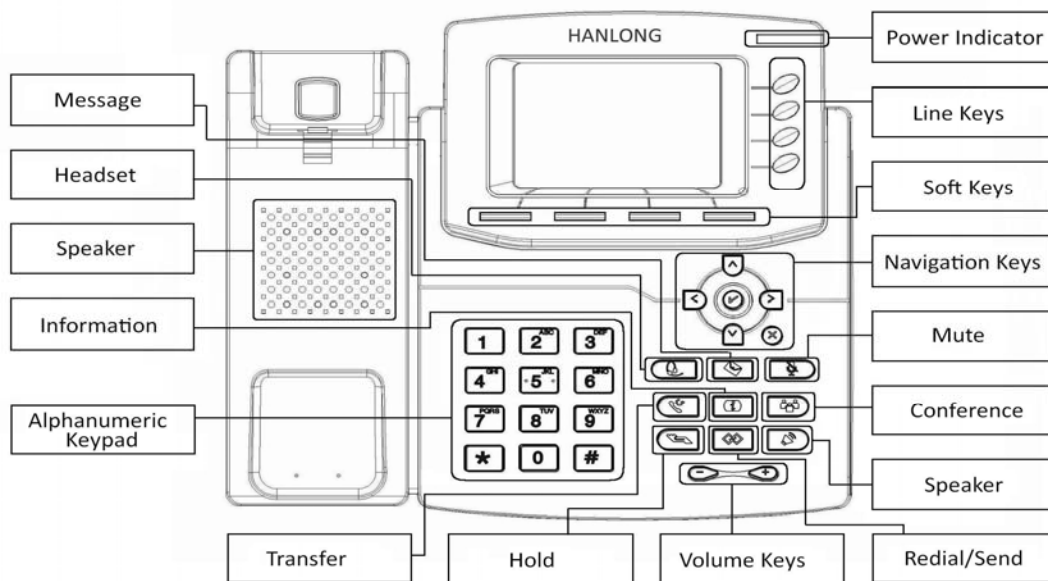

By default the phone attempts to contact a DHCP server in your network in order to obtain its valid network settings, e.g. IP address, subnet mask, default gateway, DNS server.









Getting Familiar with Your Phone

Hardware Components Preview





















Item	Description
LCD screen	To Presentation all information about the date& time, accounts, soft keys, messages, calls and other some information.
Power Indicator LED	To indicate the power status
Line keys	The phone supported up to 4 accounts 1. Steady green: idle interface, during a call.. 2. Blink red: a call incoming
Soft keys	Labels automatically to identify their context-sensitive features.
Navigation keys	 1. OK.  Up arrow key: To move up of the selection shows on the screen. 

	<p>Right arrow key: To move right of the selection shows on the screen.</p> <p> Left arrow key: To move left of the selection shows on the screen.</p> <p> Down arrow key: To move down of the selection shows on the screen.</p> <p> <ol style="list-style-type: none"> 1. To return to idle screen. 2. To cancel the information or call on the screen. </p>
Mute key	<p> <ol style="list-style-type: none"> 1. To mute the voice during the call (green light). 2. To un-mute the call. </p>
Conference	<p> To place a conference call</p>
Line Keys	<p>To be configured as different function as:</p> <ol style="list-style-type: none"> 1. Line 2. Speed Dial 3. BLF 4. BLF List 5. Voice mail 6. Direct Pickup 7. Group Pickup 8. Call Park 9. Intercom 10. DTMF 11. Prefix 12. Hold 13. Conference 14. DND 15. Redial 16. Transfer 17. SMS 18. Hot-desking 19. Call Return 20. Paging 21. Record 22. Shared Line <p>The LED lights status when set as Shared line:</p> <p>Stay green: Idle</p> <p>Stay red: Busy</p> <p>Blinked green: Ring Back</p>

	<p>Blinked red: A call incoming</p> <p>Steady orange: During a call</p> <p>Blinked orange: Public Hold</p> <p>Blinked green: Private Hold</p> <p>Light Drown: Unregistered</p>
Speaker	 Press this button to place a call in hands-free mode.
Redial	 To dial the previous dialed number. To act as send key.
Volume	 To decrease the volume.  To increase the volume.
Hold	 To hold or to resume a call during a conversation.
Information	 To show the accounts status and some other relevant information.
Transfer	 To transfer a call to a third party. To enable or disable Forward feature during the idle page.
Alphanumeric keypad	To enter the phone numbers, letters and so on.
Message	 To indicator the New message, and press to read.
Headset	 To indicate that the phone is or not in Headset mode.

Icon Preview

Icon	Description
	Network available
	Network down
	Registered succeed
	Unregistered
	Speakerphone mode
	Handset mode
	Headset mode
	Voice messages
	Text message
	Mute
	Do Not Disturb
	Hold
	Dialed calls
	Received calls
	Forward calls

	Conference
	Keypad locked
	Keypad unlocked

Line Key Function Overview

Line
Speed Dial
BLF
BLF List
Voice Mail
Direct Pick Up
Group Pick Up
Call Park
Intercom
DTMF
Prefix
Conference
Forward
Transfer
Hold
DND
Redial

Call Return

Record

URL Record

Paging

Group Listening

Public Hold

Private Hold

Shared Line

URL

Basic Features Configuration

This part will mainly introduce the basic configuration as the Time, Language, and Volume...

Web Login

1. Get the IP address: Press Menu → Status → Information.



2. Input the IP Address in the web browser.
3. Input the user name (default is admin), password (default is admin).
4. Login successfully.



The screenshot shows the web management interface with a navigation bar at the top containing: Home | Account | Network | Function Keys | Setting | Directory | Management. The main content area is titled "Status" and is divided into two main sections: "Version" and "Account Status".

Version	
Product Model	UC842
Firmware Version	BOOT-1.0.3.26(2013-10-14 11:29:00) IMG-1.0.3.59(2013-12-14 17:20:00) DSP-6.1.6(Patch 1.0.0)

Account Status	
Account1	Registered
Account2	Unregistered
Account3	Unregistered

NOTE

Version:
It shows product type and the version of firmware.

Account Status:
It shows the registered status of accounts.

Network:
It shows the information of WAN port and LAN ports.

Note:

The PC and phone should be in the same segment.

When register the accounts in web and the server port is not “5060”, then “SIP Server” should be set as “SIP Server’s IP address: server port.”, for example, “192.168.0.122:5090”.

Administrator Password

The password is mainly used for login the web interface or set the advanced settings through phone interface. And the default password of the administrator is: **admin**

To change to password via Phone Interface

1. Press Menu → setting → Advanced settings → password (default admin) → Phone Setting → Set Password
2. Enter the current PWD (password), New password and confirm the new password.
3. Press save soft key or  to save the new password.



To change to password via Web Interface

1. Management → Password
2. Fill the value
3. Click  to save the configuration.

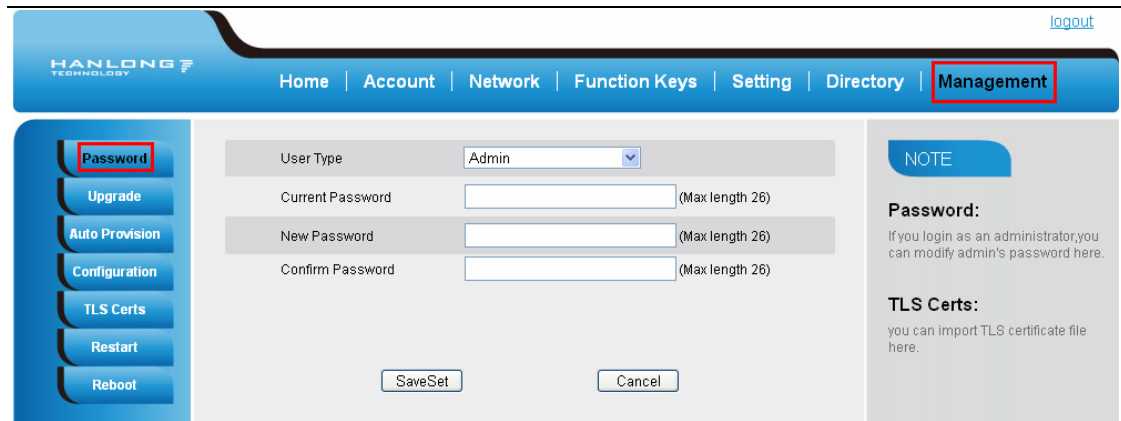

Note:
When you use the web interface: **user name: admin** **password: admin(default)**

Language

The default Phone interface language is English.

To change the language via Phone interface

1. Press Menu → Setting → Basic Settings → Language.





2. Press  or Save soft key to save the configuration.



To change the language via Web Interface

1. Phone → Preference → Web Language
2. Select the necessary one.
3. Press  to save the configuration.







Note:

All languages may not be available for selection. The available languages depend on the language packs currently loaded to the IP phone.

Time and Date

The time and date show on the idle page, and it can be set and change by SNTP server automatically or manual setting.

To configure the time and Date by SNTP setting



1. To press Menu → Setting → Basic setting → Time & Date → SNTP Settings
2. Press  or , or  to change the Time zone.
3. Fill the NTP server1, NTP Server2, and Daylight Saving.
4. Press  or Save soft key to save the configuration.



Note:







Press , all zone will show on the display, select the one you want and press save or confirm key to save the configuration.

To configure time and date manually

1. To press Menu → Setting → Basic setting → Time & Date → Manual Settings
2. Press  and  or change the right time, or you can input the right time.
3. Press  or Save soft key to save the configuration.







To configure the Time & Date Format

1. To press Menu → Setting → Basic setting → Time & Date Format
2. Press  and  or press  to change between 12 Hour or 24 Hour.
3. Press  and  or press  to change among Y-M-D(year-month-day), M-D-Y(month-day-year), D-M-Y(day-month-year).
4. Press  or Save soft key to save the configuration.



To configure the DHCP time

1. To press Menu → Setting → Basic setting → DHCP time
2. Press  and  or press  to change between Disable and Enable.
3. Press  or Save soft key to save the configuration.



To configure the Time and Date by web interface

1. Login
Login name: admin, password: admin(default)
2. Network → Advanced → NTP Server
3. Fill the value in the blank.

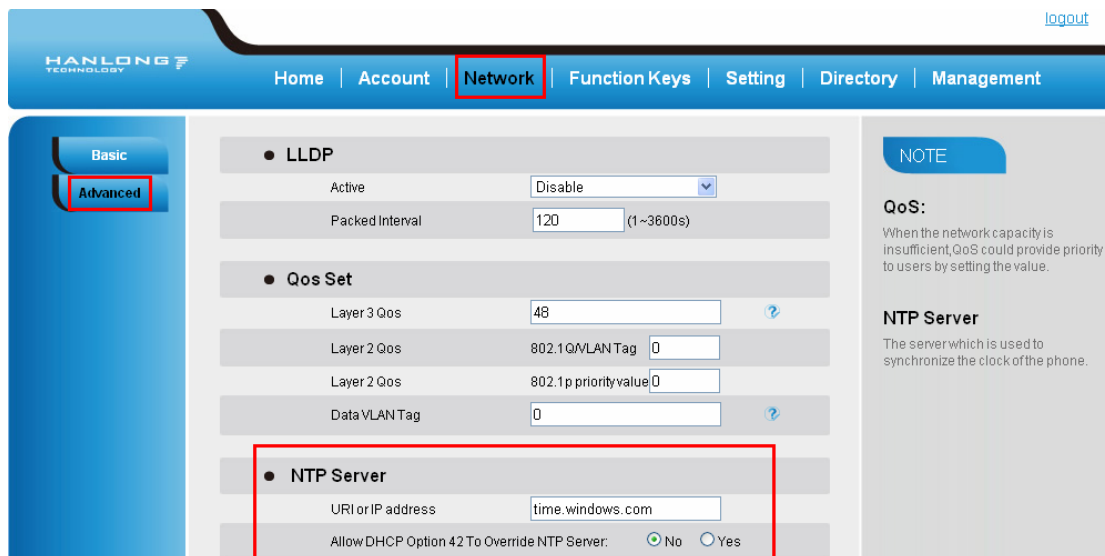

To change the Time Zone and Date Display Format via web interface

1. Setting → Preference → Time Zone
2. Select the necessary one.
3. Press  to save the configuration.

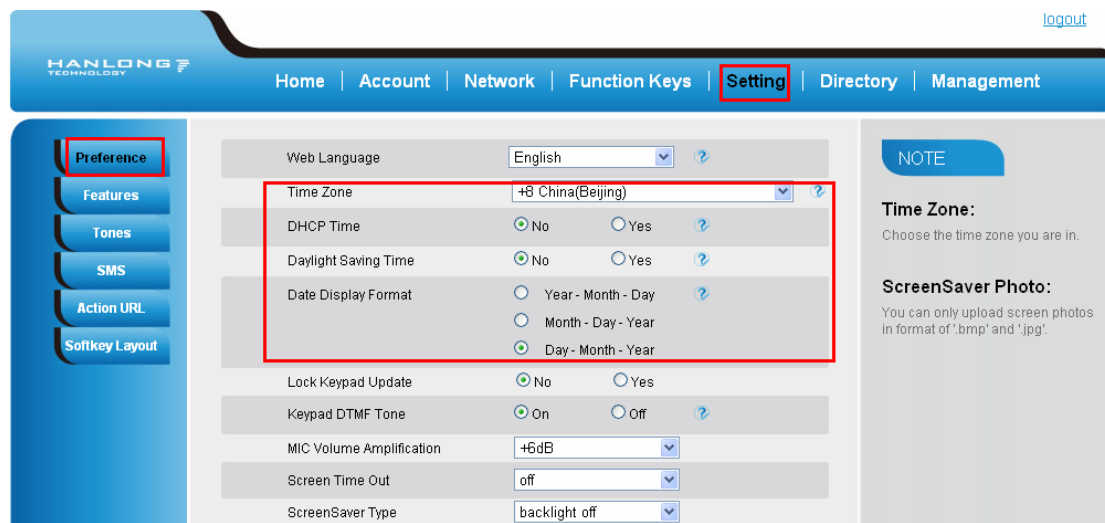



Note:

If the IP Phone cannot obtain the time and date from the Simple Network Time Protocol (SNTP) server, please contact your system administrator for more information.

Ring Tone

You can adjust the type and volume of the ring tone.

To adjust the Ring Tone Type via Phone interface

1. Press Menu → Setting → Basic Settings → Ring Tone.
2. Press  and  to select the aimed one.
3. Press  or Save soft key to save the configuration.



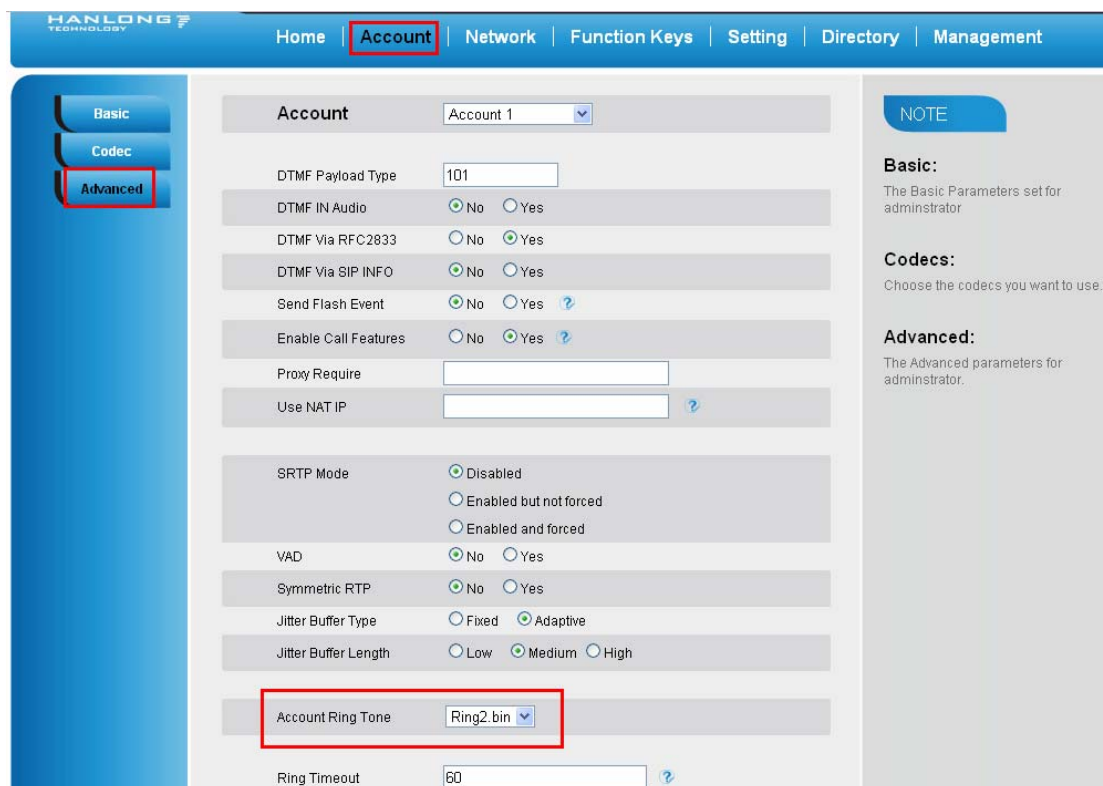

To adjust the Ring Tone Type via Web Interface

1. Account → Advanced → Account Ring Tone
2. Select the wanted one
3. Click  to save the configuration.



To configure Distinctive Ring Tone Via Phone Interface

1. Press Directory
2. Select the target contact
3. Press Detail soft key to edit the contact.
4. Press  and  to select the wanted Ring Tone for the contact
5. Press Save soft key to save the contact.

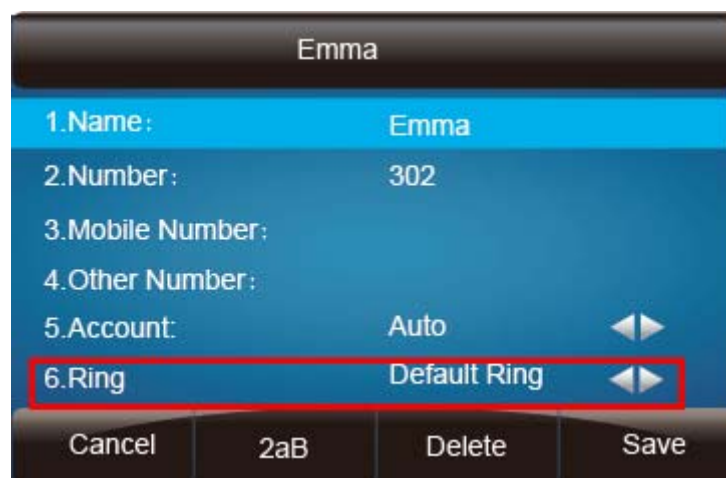

To configure Distinctive Ring Tone Via Web Interface

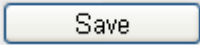
1. Directory → Directory → Contact
2. Choose the Ring Tone you want to use.
3. Click  →  to save the configuration.

HANLONG TECHNOLOGY

Home | Account | Network | Function Keys | Setting | **Directory** | Management

Directory

- Remote Phone Book
- Call History
- LDAP
- BroadSoft
- Calllog

Contact | **BlackList** | Hangup

Index	Display Name	Office Number	Mobil Number	Other Number	Account	All
1	Emma	302		303	Auto	<input checked="" type="checkbox"/>
2	Joe	304			Auto	<input type="checkbox"/>

Save | Delete | Move To Black List

Contact

Name: Joe

Office Number: 304

Mobile Number:

Other Number:

Account: Auto

Ring: Ring3.bin

Group: Not In Group

Photo: Auto

Add | **Edit** | Search

Import Local Contacts

NOTE

Add Contact/Blacklist
Fill out the contact information. User shouldn't leave contact name blank.

Delete Contact/Blacklist
Select the contact you want to delete in the grid, and then press the button Delete to confirm.

Move to Contact/blacklist
Choose the contacts you want to move in the grid, and press the button move to Contact/Blacklist to move it.

Upload Photo
The format of the photo supported is jpg or bmp, and the size should be less than 128*128

Import
Browse the file in XML format.

Export
Click Export button and create a file with whose name you prefer to export.



Volume

You can adjust the volume for the phone by the volume keys: and .





To adjust the Ring tone volume

- Option 1: To press and on the idle page



2. Option 2: To press  and  during the call is ringing.

To adjust the handset volume

To press  and  during a call in handset mode.





To adjust the headset volume

To press  and  during a call in headset mode.



To adjust the speaker Volume



To press  and  during a call in speaker mode.



Wallpaper

To change the preferred one picture for you by the following steps:

To change the wallpaper



1. To press Menu → Display → wallpaper
2. Press  and  or press Switch soft key to display the different pictures.
3. Press  or Save soft key to save the selected picture as the wallpaper.



Screen Saver



There are three types of screen saver: Backlight off, Time & Logo and Photo Switch.

To enable screen saver via Phone

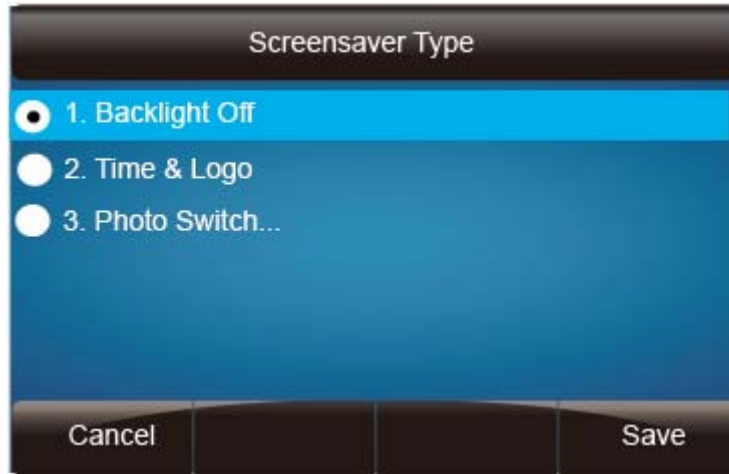
1. To press Menu → Display → Screensaver...
2. Press  and  or press Switch soft key to Choose the Time-out as 1 min or 2/5/10/30 minute.
3. Enter the Screensaver Type to choose one of the type: Backlight off, Time & Logo and Photo
4. Press  or Save soft key to save the selected configuration.



To disable screen saver via Phone

1. To press Menu → Display → Screensaver...
2. Press  and  or press Switch soft key to Choose the Time-out as off.
3. Press  or Save soft key to save the selected configuration.

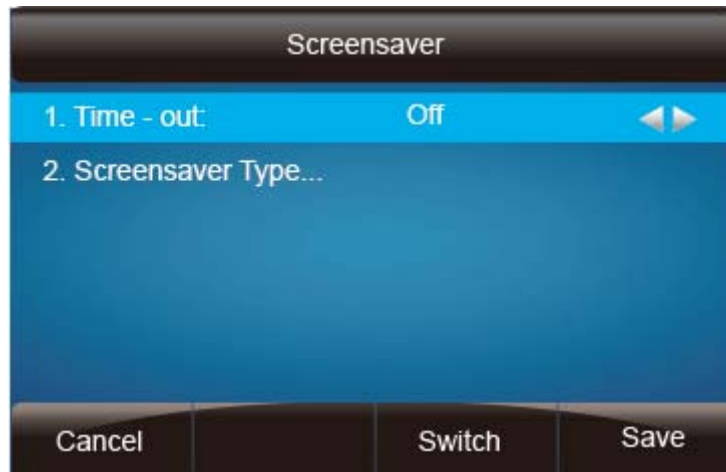

To upload screen saver via Web

1. Setting → Preference
2. Choose the picture wanted to use as screen saver
3. Click Upload Photo to save the upload picture



Directory

In the directory, you can add or delete your friends, business partner or anyone others' phone No. so you will not forget their number. Or put some anonymous phone No. in the blacklist to prevent from being disturbed.





A. To add contacts list into local directory

To add contacts manually

1. Press Menu → Directory → Local Contacts
2. Press Add soft key.
3. Enter the necessary information as Name, Phone number...
4. Press save soft key or  to add the contacts successfully.



To add contacts from history

1. Press History soft key or press Menu → History → Local history
2. Press  and  to select the targeted one. (Press  and  switched among the All calls, Dialed calls, Received calls, Missed Calls and Forward Calls).
3. Press Option soft key → Add to Contacts
4. Edit the necessary information as Name, Phone number...
5. Press save soft key or  to add the contacts successfully.

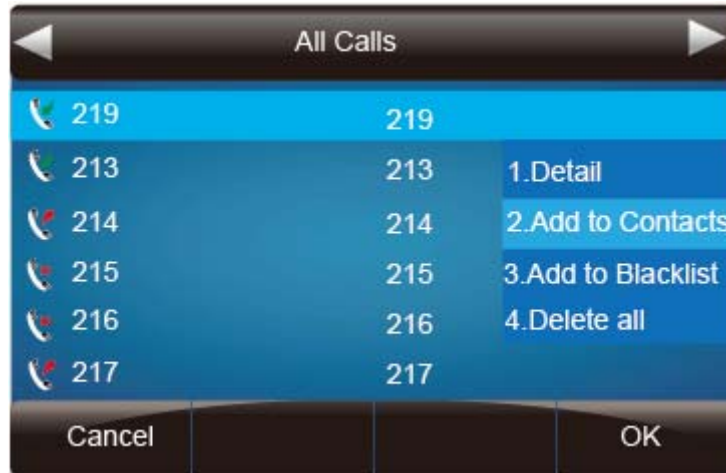

To add contacts via web interface

1. Click Directory
2. Enter the name, number and some other information.
3. Press Add and then press Save button.

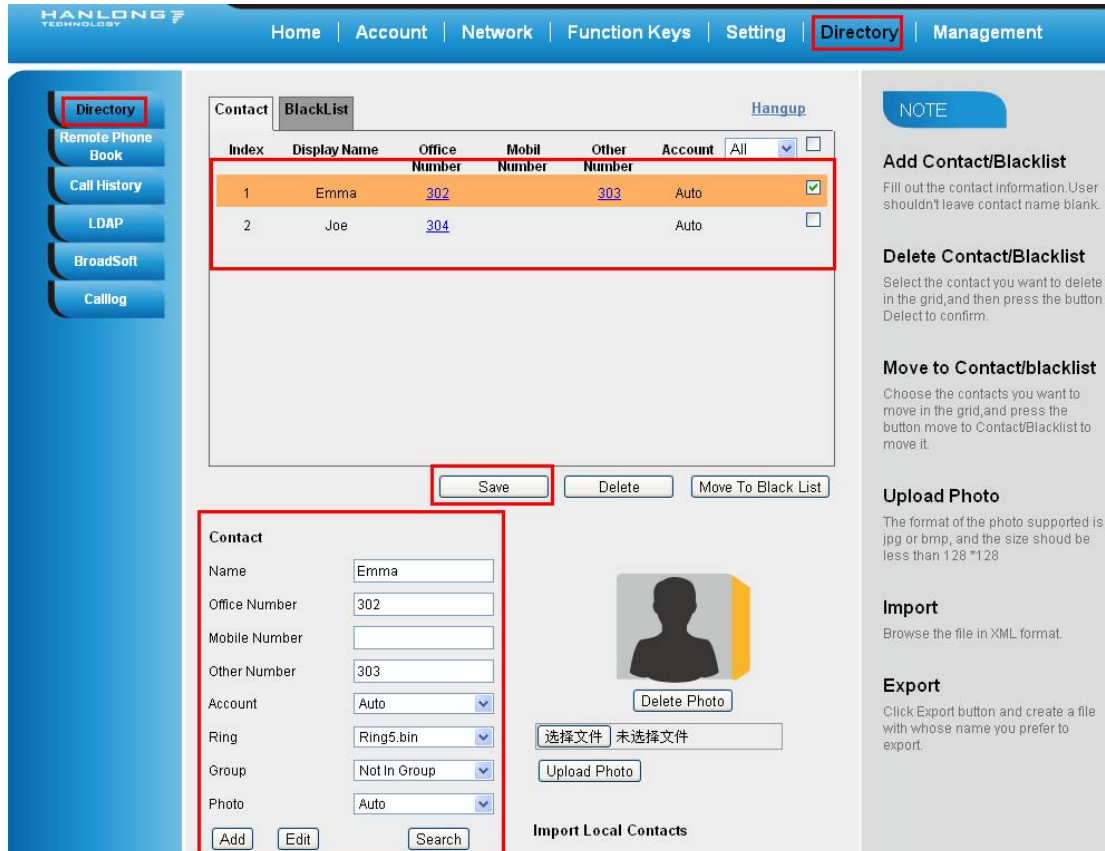

Directory

Home | Account | Network | Function Keys | Setting | **Directory** | Management

Remote Phone Book
Call History
LDAP
BroadSoft
Calllog

Index	Display Name	Office Number	Mobil Number	Other Number	Account	All
1	Emma	302		303	Auto	<input checked="" type="checkbox"/>
2	Joe	304			Auto	<input type="checkbox"/>

Hangup

Save
Delete
Move To Black List

Contact

Name:

Office Number:

Mobile Number:

Other Number:

Account:

Ring:

Group:

Photo:

Add
Edit
Search



Delete Photo

选择文件 未选择文件

Upload Photo

Import Local Contacts

NOTE

Add Contact/Blacklist
Fill out the contact information. User shouldn't leave contact name blank.

Delete Contact/Blacklist
Select the contact you want to delete in the grid, and then press the button Delete to confirm.

Move to Contact/blacklist
Choose the contacts you want to move in the grid, and press the button move to Contact/Blacklist to move it.

Upload Photo
The format of the photo supported is jpg or bmp, and the size should be less than 128*128

Import
Browse the file in XML format.



Export
Click Export button and create a file with whose name you prefer to export.

B: To add contacts into blacklist

To add blacklist manually

1. Press Menu → Directory → Blacklist
2. Press Add soft key.
3. Enter the necessary information as Name, Phone number...
4. Press save soft key or  to add the contacts successfully.

To add blacklist from history

1. Press History soft key or press Menu → History → Local history
2. Press  and  to select the targeted one.
3. Press Option soft key → Add to Blacklist
4. Edit the necessary information as Name, Phone number...
5. Press save soft key or  to add successfully.

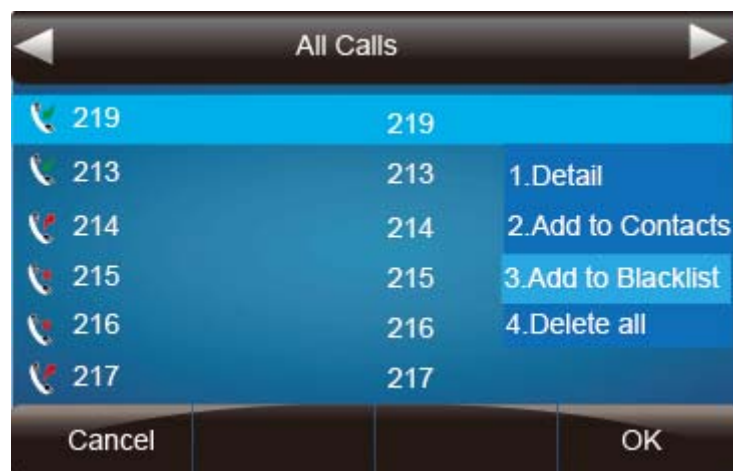

Basic Call Features



Place a Call

There are three ways to dialing a call: Handset, Headset and Hands-free speakerphone.



To place a call by Handset

1. Pick up the handset, or press a line key and dial the necessary number.
2. Press  or press the send softkey, then the call is sending.



To place a call by Headset:

1. Press the  (light is Green),
2. Enter the desired number.
3. Press  or press the Send softkey, then the call is sending.

Placing a call by hands-free speakerphone

1. Press the , or press the Line key, then you can hear the dial tone.
2. Press the number.
3. Press  or press the Send soft key, then the call is sending.

To place a call by call history or Directory

1. Press the History soft key (On the idle page) or Menu → History /Directory
2. Press  and  to select the targeted one.
3. Press Send soft key to make the call.

Note:

1. The  key is set to be a send key. You can set the * key as send key or set some other to be as send keys. For more information, refer to the Key as Send on page
2. During the call, you can also change among **Headset, Handset** or **Free-speaker mode**.

End a Call

Here shows to end a call during three mode:

To end a call by Handset

1. Press the Cancel soft key or hang up the handset.

To end a call under Headset Mode

1. Press the Cancel soft key or press .

To end a call under hands-free speakerphone Mode

1. Press the Cancel soft key or press .

Note:

1. During the conference, to end the call is same as mentioned above.

Redial a Call

To redial the last placed call from the IP Phone

Press  directly when LCD is on the idle interface.

Receive a Call

There are three ways to receive a call when the phone is ringing:

To receive a call by handset

Pick up the handset the conversation is built.

To receive a call by headset

Press  and now the conversation is built.

To receive a call by hands-free speaker

1. Option 1: Press  directly.
2. Option 2: Press Answer soft key.
3. Option 3: Press the Line key (flashes red).

Moreover, some other action can be done by soft key when the call is coming.

1. To press the Reject soft key to reject the call. Or press  to reject the current call.
2. To press Forward to forward to another phone.
3. To press Silence soft key, and then the call will keep silent, no ring tone display.

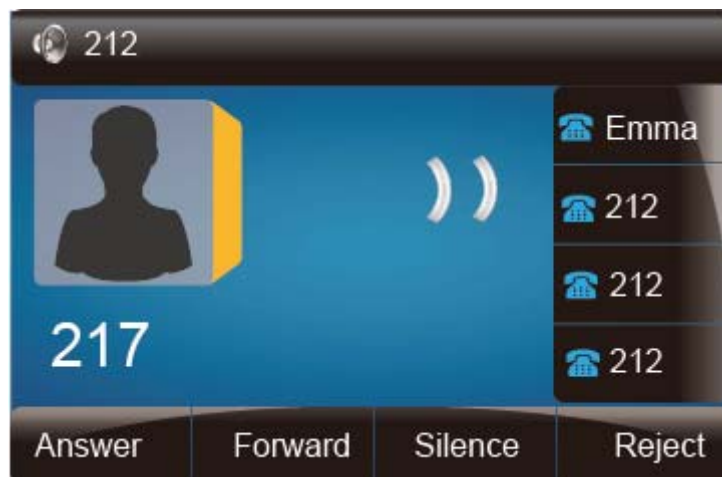

Auto Answer

Enable auto answer feature, you will answer all incoming call automatically.

To enable Auto Answer via Webpage

1. To Click Account → Advanced
2. To choose Yes for the Auto Answer.
3. To click Saveset to save the configuration.

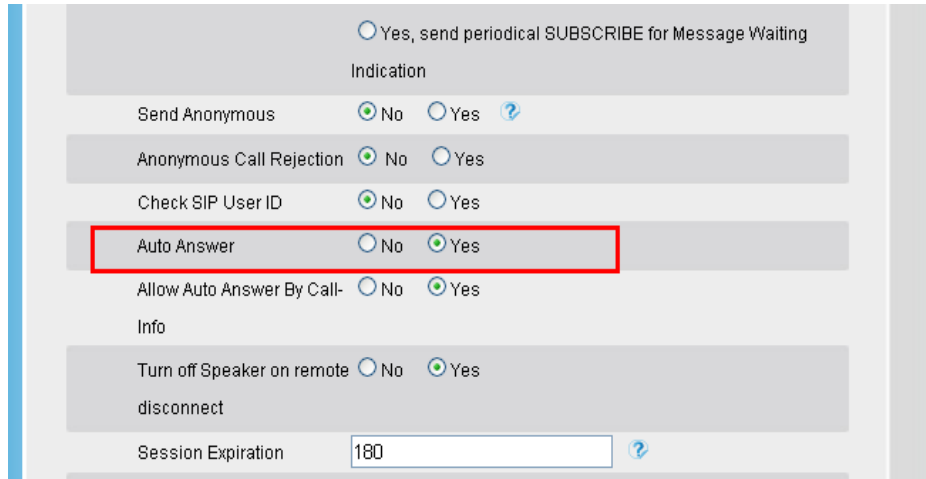

Yes, send periodical SUBSCRIBE for Message Waiting Indication

Send Anonymous No Yes ?

Anonymous Call Rejection No Yes

Check SIP User ID No Yes

Auto Answer No Yes

Allow Auto Answer By Call- No Yes

Info

Turn off Speaker on remote disconnect No Yes

Session Expiration ?

To Disable Auto Answer via Webpage

1. To Click Account → Advanced
2. To choose No for the Auto Answer.
3. To click Saveset to save the configuration.

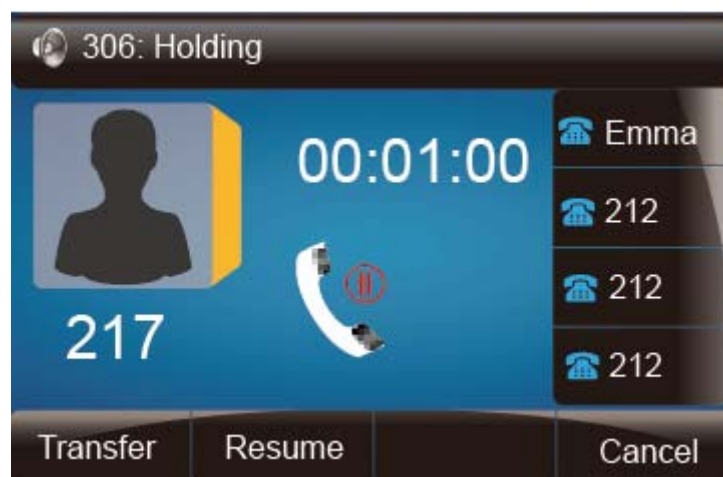

Call Hold

When use hold feature, the Hold icon will show on the display.





To make a call on hold during three modes:



To hold a call under handset mode:

1. Press Hold soft key or  to hold the current call.
2. Press Resume soft key or  to resume the call on hold.

To hold a call under headset mode:

1. Press Hold soft key or  to hold the current call.
2. Press Resume soft key or  to resume the call on hold.

To hold a call during the speaker mode:



1. Press Hold soft key or  to hold the current call.
2. Press Resume soft key or  to resume the call on hold.

Call Transfer

This phone supports blind, attended and Semi-Attended Transfer.

Blind Transfer

When you use this feature, you can transfer

1. Press  or Transfer soft key during the conversation, the call is on hold now.
2. Enter the number that transfers to.
3. Press , and now the blind transfer completed.

NOTE:



The “Enable Call Feature” must be configured to “Yes” to enable this feature.

Attended Transfer

When you use this feature, you can

1. Press  or transfer soft key during the conversation, the call is on hold now.





2. Enter the number that transfer to, and press the send soft key or .
3. Start the second conversation, press  or transfer soft key, then, transfer completed.

NOTE:

To transfer calls across SIP domains, SIP service providers must support transfer across SIP domains. Blind transfer will usually use the primary account SIP profile. To use this function, should at least one line key set as Auto.

Semi-Attended Transfer

1. Press  or transfer soft key during the conversation, the call is on hold now.
2. Enter the number transfer to, and then press , then you can here the ring tone.
3. Press  or the Tran soft key, and now the Semi-attended transfer completed.

NOTE: To use this function, should at least one line key set as Auto.







BLF Transfer

1. Set a Programmable Key or line key is set as BLF. For how to set BLF, please refer to [BLF](#)
2. Press  or transfer soft key during the conversation, the call is on hold now.
3. Press BLF key then realize blind, attended and Semi-Attended Transfer.

Call Conference

This IP Phone supports up to 5-way conference.

5-way conference

1. Assuming that call party A and B are in conversation. A wants to bring C, D and E in a conference
2. A press line 2 key, the call is placed on hold.
3. A enter the number of C and then press send soft key or .
4. C answering the call.
5. A press  or the conference soft key, then A, B and C are now in a conference.(and now this is **3-way conference**)
6. A press line 3 key, the current 3-way conference is placed on hold.
7. A enter the number of D and then press send soft key or .
8. D answering the call.
9. A press  or the conference soft key, then A, B, C and D are now in a conference.(and now this is **4-way conference**)
10. A press line 4 key, the call is placed on hold.
11. A enter the number of E and then press send soft key or .
12. E answering the call.
13. A press  or the conference soft key, then A, B, C, D and E are now the **5-way conference** is built.
14. A end the call, the conference is finished.



Note:

1. If C does not answer the call, A can back to continue the conversation with B;
2. Once A hangs up the call, the conference is ended, while if B or C drops the call, A&C or A&B conversation continues.
3. The conference feature is not available on all servers. For more information, contact your system administrator.
4. To realize the 5 way conference, the line should be all available.
5. Press  to get all parties information.

Call Forward



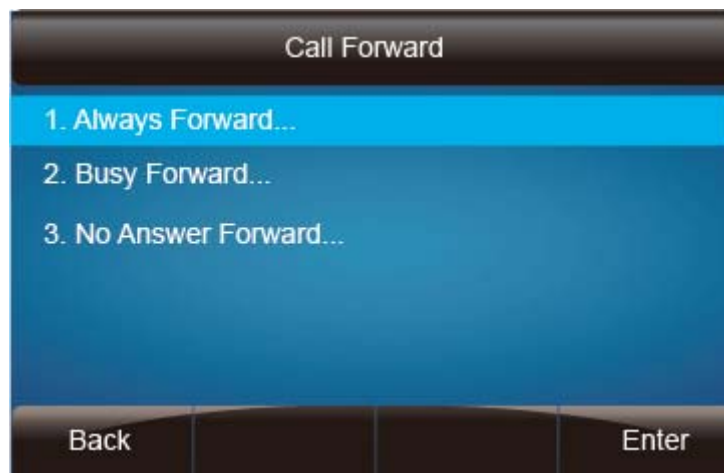

This phone supports static forward (always forward, busy forward and no answer forward) and dynamic forward



To configure static forward

To configure always forward





With this feature, all incoming calls will forward immediately to configured number.

1. Press Menu → Features → Call forward → Always Forward.
2. Press  and  or press  to select the enable choice
3. Enter the forward to number and on code (optional), off code (optional).
4. Press  or Save soft key to save the configuration.



To configure busy forward



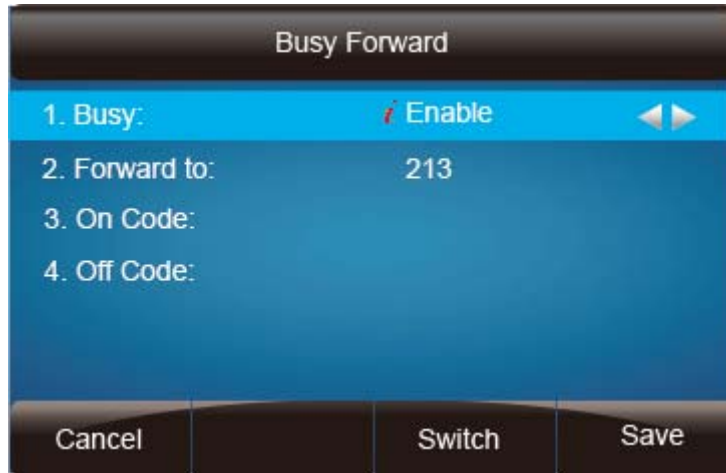

With this feature, the incoming calls are immediately forwarded if the phone is busy.

1. Press Menu → Features → Call forward → Busy forward.
2. Press  and  or press  to select the enable choice.
3. Enter the forward to number and on code (optional), off code (optional).
4. Press  or Save soft key to save the configuration.



To configure no answer forward

No Answer Forward: Incoming calls are forwarded if not answered after some time.

1. Press Menu → Features → Call forward → No answer forward.
2. Press  and  or press  to select the enable choice
3. Enter the forward to number and on code (optional), off code (optional).
4. Press  or Save soft key to save the configuration.

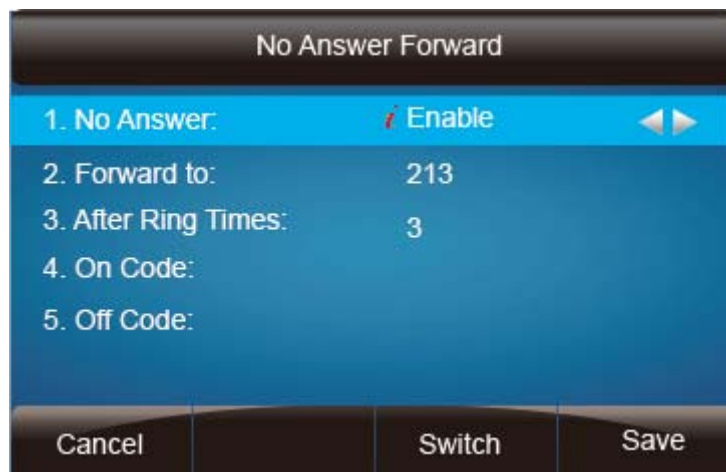

When the Forward feature is enabled, the Icon  will display on Top of the LCD.



To configure Forward via Web Interface

1. Setting → Feature
2. Click On for the Always/Busy/No Answer
3. Fill the Forward to Number
4. (Optional) fill the on/off code
5. Click to save the configuration

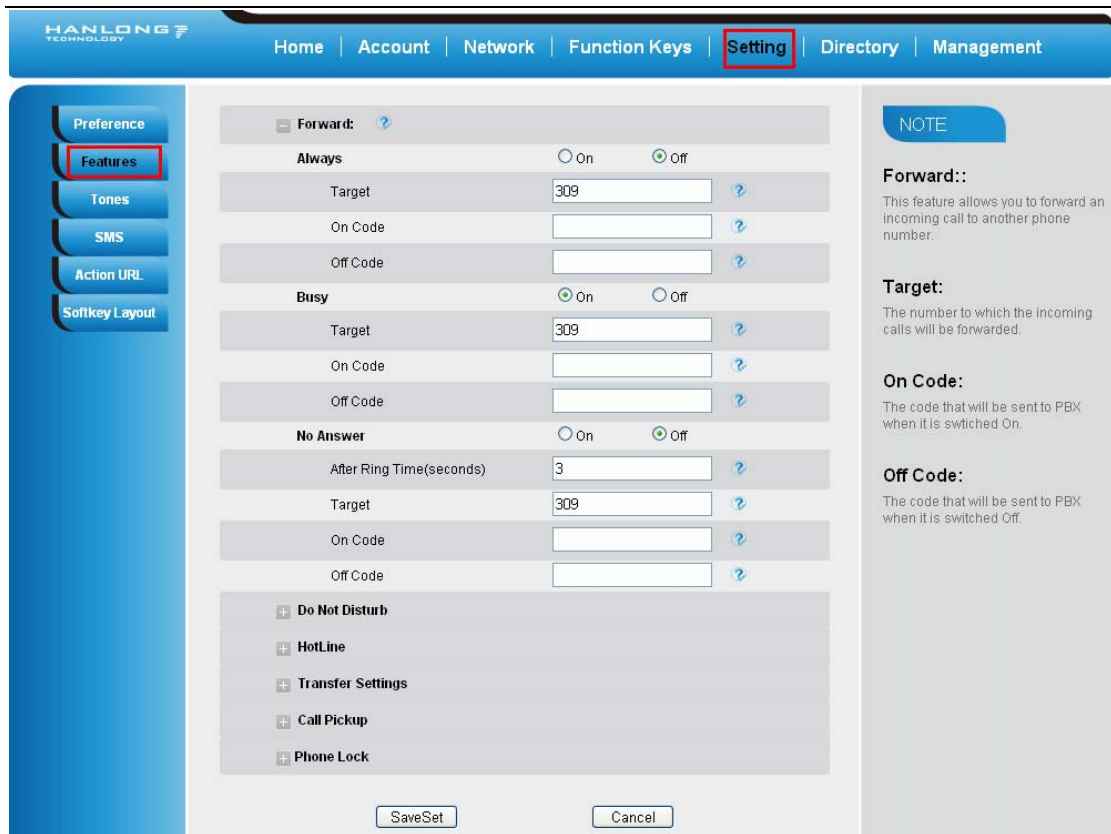

To cancel the forward feature via Phone Interface

- Option 1: To press the key to disable the forward feature.
- Option 2: Press Menu → Features → Call forward → Always/Busy/No answer Forward
 Press and or press to select the disable choice
 Press or Save soft key to save the configuration.

To cancel the forward feature via Web Interface

- Phone → Feature
- Click Off for the Always/Busy/No Answer
- Click to save the configuration

To configure dynamic forward

Forward an incoming call during the ringing.

1. When the phone is ringing, press Forward soft key.
2. Enter the forward number.
3. Press  or press the send soft key, then the call is forwarded.

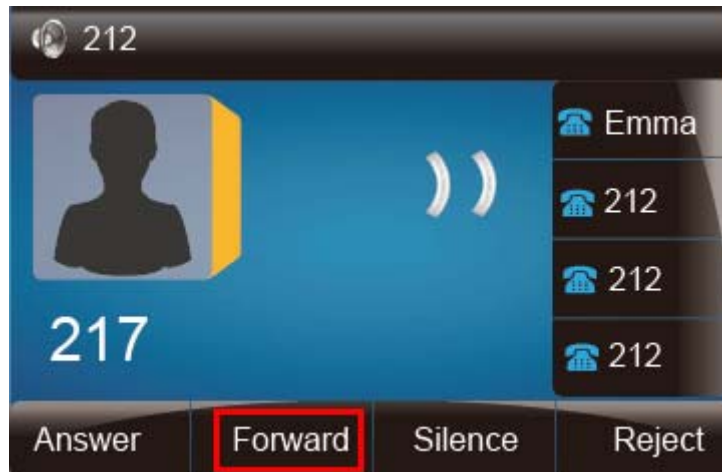







Note:

If the Programmable Key or line key is set as BLF, when an incoming call ringing, press this BLF key directly to realize the dynamic forward.

Call Return

This feature allows you to dial the last phone call you received.

To configure the Call Return via phone interface

1. Press Menu→Features→Function Keys→Line Key as Function Keys
2. Select the wanted Line key.
3. Press  and  or press  key to select the Key Event in the type field.
4. Press  and  or press  key to select the Call Return.
5. Press  or Save soft key to save the configuration







To configure the Call Return via Web interface

1. Click Function keys → Line key.
2. Select the desired Line key and select Call Return in the Type.
3. Click the  to save the configuration.

Hide Caller ID

Just enable the anonymous call feature, you can set your ID do not appear on the other phone that you called.



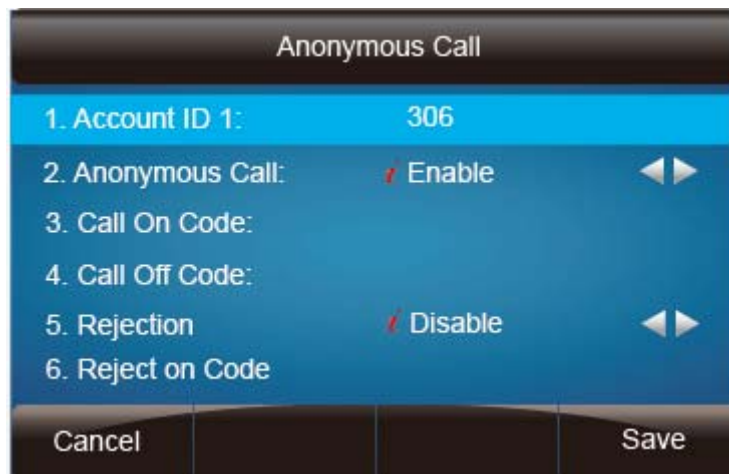

To configure anonymous call

1. Press Menu → Features → Anonymous Call
2. Press  and  or press  to change the Line ID
3. Press  and  or press  to select the enable choice in Anonymous Call filed.
4. Enter the call on code (optional), call off code (optional).
5. Press  or Save soft key to save the configuration.



To cancel anonymous call feature







1. Press Menu → Features → Anonymous Call

2. Press  and  or press  key to select the disable choice in Anonymous Call filed.
3. Press  or Save soft key to save the configuration.

Reject Anonymous



If you do not want to be disturb by anonymous calls, you can set the reject anonymous call features, so you will not hear the unknown calls

To configure rejecting anonymous call

1. Press Menu → Features → Anonymous Call
2. Press  and  or press  key to change the Line ID
3. Press  and  or press  key to select the enable choice in Rejection filed.
4. Press  or Save soft key to save the configuration



To cancel rejecting anonymous call

1. Press Menu → Features → Anonymous Call
2. Press  and  or press  key to select the disable choice in Rejection filed.



3. Press  or Save soft key to save the configuration.

Call Mute

When you use the Mute feature, the other parties will not hear your voice while you can hear their voice. Call mute applies to all modes (handset, headset, and speakerphone).



To mute the call during a call (including a conference call)

1. Press the mute key , then the mute key glows green, and the LCD display 
2. To disable the mute function, press  again.

DND

When you use the DND feature, the phone is to reject all incoming calls automatically and you

can see the mute icon  shown on the Top of the LCD on idle page.



To enable DND feature





1. Press the DND soft key when the phone is idle, and then  shown on the LCD.

To disable DND feature

1. Press the DND soft key again, and then there is no  on the LCD.



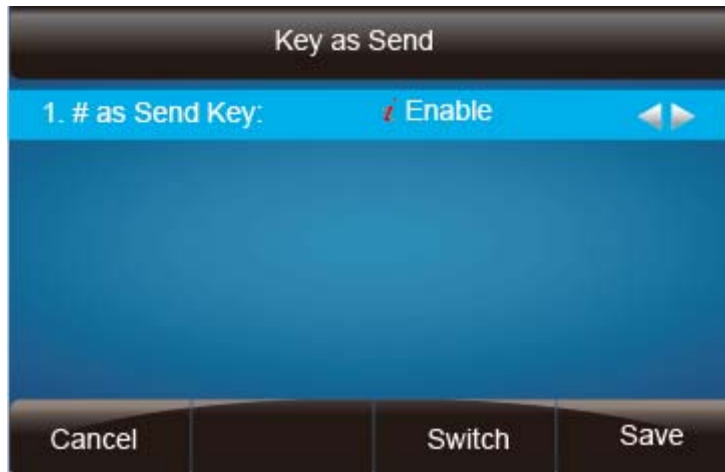

Key as Send

To configure Key as Send

1. Press Menu → Features → Key as Send
2. Press  and  or press  key to select the enable choice.
3. Press  or Save soft key to save the configuration



To cancel # Key as Send

1. Press Menu → Features → Key as Send
2. Press  and  or press  key to select the disable choice.
3. Press  or Save soft key to save the configuration

No Key Entry Timeout

No Key Entry Timeout means that when you enter the number, it will dial out automatically after some time when you stop enter the number.

To configure No Key Entry Timeout

1. Click Webpage Setting → Preference
2. Fill the blank of No Key Entry Timeout: for example 5(seconds).(0 means never timeout, you should press the send key the dial out the number.
3. Click the  to save the configuration.

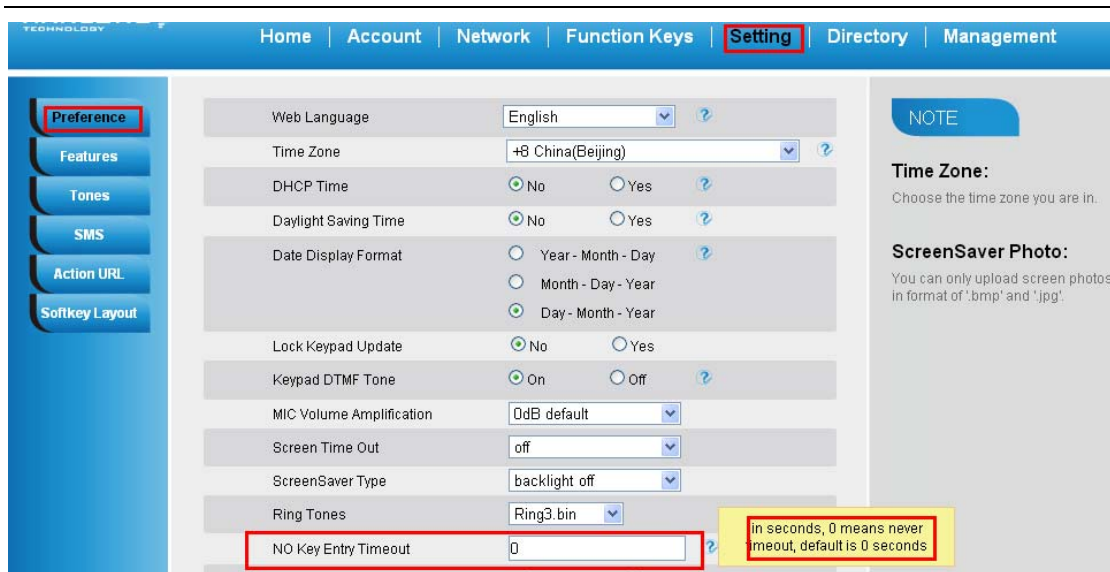

Keypad Lock

To enable Keypad Lock via Phone

1. Press Menu--Settings--Advanced Setting--Phone Setting--Lock
2. Press Info or Switch to change choose lock type:All Keys Menu Key Function Key Lock & Answer
3. Press Save or OK key to save the configuration.

To enable Keypad Lock via Phone

1. Press Menu--Settings--Advanced Setting--Phone Setting--Lock
2. Press Info or Switch to change choose Off.
3. Press Save or OK key to save the configuration.

To enable Keypad Lock via Webpage

1. Click Webpage Setting → Preference
2. To choose the Lock keys.
3. To fill the unlock PIN and auto lock time
4. Fill the Emergence Number, when the phone is Lock, only Emergency Number can be sent.

5. To click Saveset to save the configuration.

Phone Lock	
Keypad Lock	Function Keys
Phone Unlock Pin(0~15digital)
Auto Lock Time-Out(0~3600s)	60
Emergency	

To Disable Keypad Lock via Webpage

1. Click Webpage Setting → Preference
2. To choose Disable for the Phone Lock.
3. To click Saveset to save the configuration.

Hot Line

To configure Hot Line

1. Press Menu → Features → Hot Line
2. Enter the Number and delay time (as present, we support off hook auto dial).
3. Press  or Save soft key to save the configuration

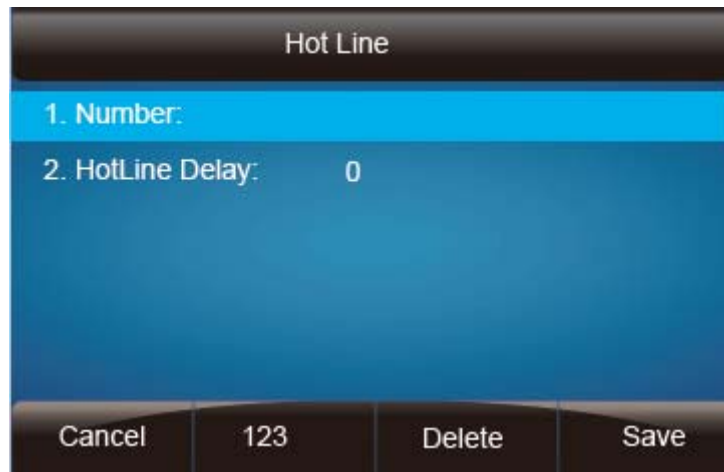

To configure Off hook auto dial via Web Interface

1. Setting → Features
2. Fill the number in the Hotline Number and the Hotline Time-out
3. Click SaveSet to save the configuration.

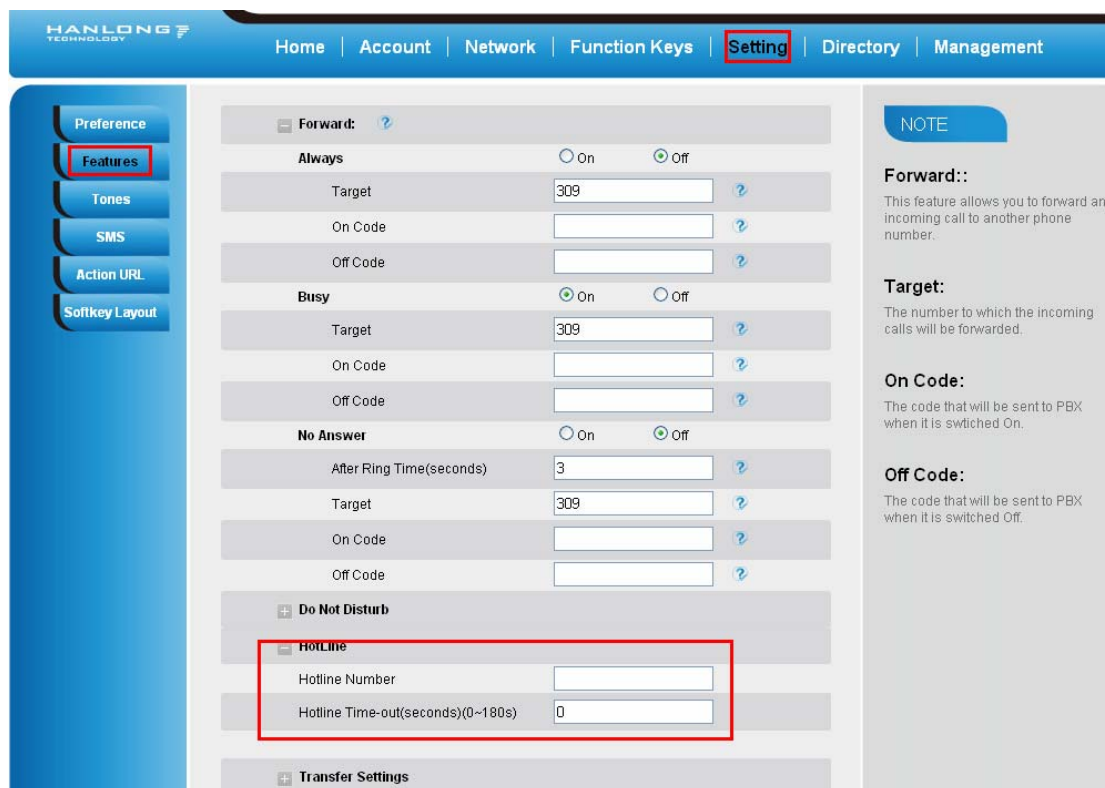

NOTE

Forward::
This feature allows you to forward an incoming call to another phone number.

Target:
The number to which the incoming calls will be forwarded.

On Code:
The code that will be sent to PBX when it is switched On.

Off Code:
The code that will be sent to PBX when it is switched Off.

Delete the number and save the configuration, and then now the Hotline is cancelled.

Advanced Features

Voice Message

This phone supports Voicemail, and when there is message, the message will  will light green. Moreover, when pick up the handset, or press speaker key, you will hear some quick busy tone.

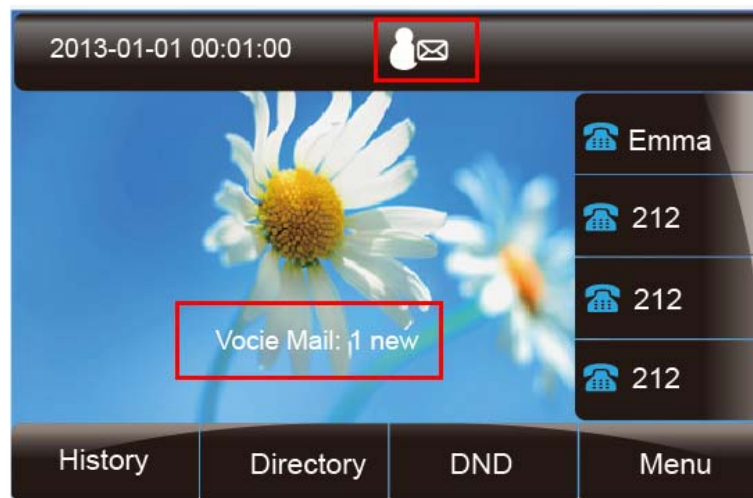

To configure the Voicemail feature

1. Press Menu→Messages→Voice Mail→Set Voice Mail.
2. Enter the Account1/2/3/4 NO.
3. Press  or Save soft key to save the configuration

Note:

This feature is not available on all servers. For more information, contact your system administrator.

Intercom

When use the intercom feature, you can quickly get access connect to the configured one.

To configure intercom feature via phone interface

1. Press Menu → Features → Function Keys → Line keys as Function Keys → Line key1 (for example)

2. Press  and  or press  key to select the intercom in the type field.

3. Enter the targeted Number.

4. Press  or Save soft key to save the configuration

Then the selected Line key will work as intercom.

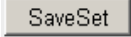

To configure Intercom feature via Web Interface

1. Click Function keys → Line key.
2. Select the wanted Line key.
3. Enter the desired phone number in the Value field.
4. Select the Account ID
5. Click the  to save the configuration.

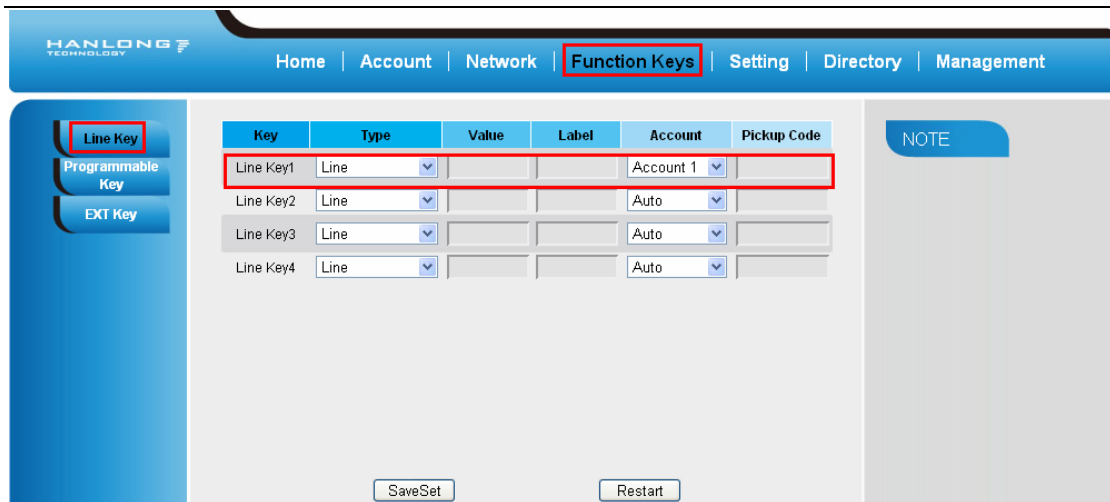





Note:

This feature is not available on all servers. For more information, contact your system administrator.

Speed Dial

With this feature, you can dial one directory by press the definite key.

To configure Speed Dial feature via phone interface

1. Press Menu → Function Keys → Line Keys as Function Keys → Line key1 (for example)
2. Press  and  or press  key to select the Speed Dial in the type field.
3. Enter the targeted Number.
4. Press  or Save soft key to save the configuration

Then the selected Line key will work as Speed Dial.

To configure Speed Dial feature via Web Interface



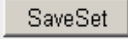

1. Click Function keys → Line key.
2. Select the wanted Line key and set as Speed Dial.
3. Enter the desired phone number in the Value field.

4. Select the Account ID
5. Click the  to save the configuration.

Direct Pickup

With this feature, you can pick up the set line when it ringing.

To configure Direct Pickup feature via phone interface

1. Press Menu → Features → Function Keys → Line keys as Function Keys → Line key1 (for example)
2. Press  and  or press  key to select the Direct Pickup in the type field.
3. Enter the value.
4. Press  or Save soft key to save the configuration

Then the selected Line key will work as Direct Pickup.



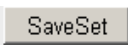

To configure Direct Pickup feature via Web Interface

1. Click Function key → Line key.
2. Select the wanted Line key and set as Direct Pickup.
3. Enter the pickup code and followed the desired phone number in the Value field.
4. Select the Account ID
5. Click the  to save the configuration.

Group Pickup

With this feature, you can pick up the specified group that you want incoming calls.

To configure the Pick up via phone interface

1. Press Menu→Features→Function Keys→Line Key as Function Keys
2. Select the wanted Line key.
3. Press  and  or press  key to select the Group Pickup in the type field.
4. Enter pickup code and followed the desired group number
5. Press  or Save soft key to save the configuration

To configure the Group Pick up via Web interface

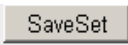





1. Click Function keys → Line key.
2. Select the desired Line key and select Group Pickup in the Type.
3. Enter the pickup code and followed the desired Group number in the Value field.
4. Click the  to save the configuration.

BLF

You can use the BLF (Busy Lamp Field) feature to monitor a specific one whether his phone is busy or free.

1. When the monitored line is idle, the light is steady green.
2. When the monitored line is ringing, the light is blinking red, press the BLF key to pick the phone up directly.
3. When the monitored line is calling or in a conversation, the light is steady red.

To configure a BLF key by phone

1. Press Menu→Features→Function Keys→Line Keys as Function Keys.
2. Select the targeted Line key.
3. Press  and  or press  key to select the BLF in the type field.
4. Enter the targeted Value Number.
5. Press  and  or press  key to select the Account ID.
6. Enter the Pickup Code.
7. Press  or Save soft key to save the configuration

To configure a BLF key by web

1. Click Function keys → Line key.
2. Select the desired Line key and select BLF in the Type.
3. Enter the monitored phone number in the Value field.
4. Select the Account ID
5. Filled the Pickup code.
6. Click the  to save the configuration and then restart.

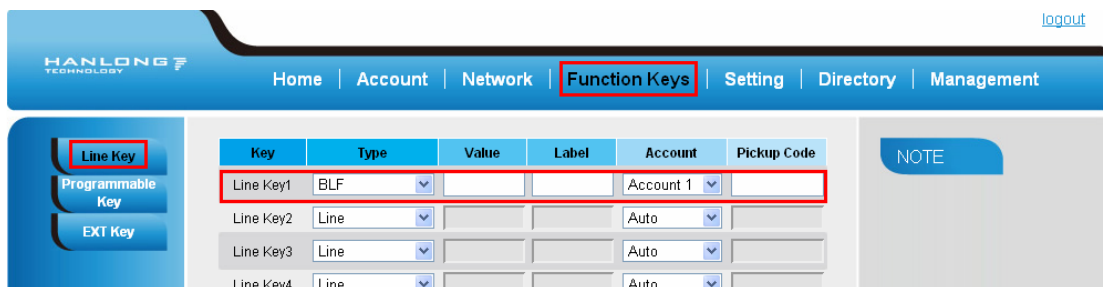

Key	Type	Value	Label	Account	Pickup Code
Line Key1	BLF			Account 1	
Line Key2	Line			Auto	
Line Key3	Line			Auto	
Line Key4	Line			Auto	







Note:

This feature is not available on all servers. For more information, contact your system administrator.

Shared Line

This feature allows subscribers to share SIP lines. Moreover it also provides status monitoring of the shared line.

To configure the line key as shared line via phone interface

1. Press Menu→Features→Function Keys→Line Key as Function keys
2. Select the wanted Line key.
3. Press  and  or press  key to select the Shared Line in the type field.
4. Press  and  or press  key to select the Account ID.
5. Enter the Label
6. Enter the Value
7. Press  or Save soft key to save the configuration

To configure the line key as shared line via Web Interface

1. Click Function keys → Line key.
2. Select the desired Line key and select Shared Line in the Type.
3. Enter the Value.
4. Enter the Label.
5. Select the Account ID
6. Click the  to save the configuration and then restart.

HANLONG TECHNOLOGY
Home | Account | Network | **Function Keys** | Setting | Directory | Management

Line Key

Programmable Key

EXT Key

Key	Type	Value	Label	Account	Pickup Code
Line Key1	Shared Line	2404984025	4025_1	Account 1	
Line Key2	Line			Auto	
Line Key3	Line			Auto	
Line Key4	Line			Auto	

NOTE







Note:

This feature is not available on all servers. For more information, contact your system administrator.

Record

With record feature, you can record calls by pressing a record key on the phone.

To configure the record via phone interface

1. Press Menu→Features→Function Keys→Line Key as Function Keys
2. Select the wanted Line key.
3. Press  and  or press  key to select the Key Event in the type field.
4. Press  and  or press  key to select the Record.
5. Press  or Save soft key to save the configuration

To configure the record via Web interface

1. Click Function keys → Line key.
2. Select the desired Line key and select Record in the Type.
3. Click the to save the configuration.





Note:

Please contact the system administrator whether support this feature or not.

Call Park

With this feature, you can put a call on hold and continue the conversation from another phone.

To configure the Call Park via phone interface

1. Press Menu→Features→Function Keys→Line Key as Function Keys
2. Select the wanted Line key.
3. Press  and  or press Switch soft key to select the Key Event in the type field.
4. Press  and  or press Switch soft key to select the Call Park.
5. Press  or Save soft key to save the configuration

To configure the Call Park via Web interface







1. Click Function keys → Line key.
2. Select the desired Line key and select Call Park in the Type.
3. Click the  to save the configuration.

Paging

With this feature, you can call a phone directly.

To configure the paging via phone interface

1. Press Menu→Features→Function Keys→Line Key as Function Keys



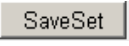

2. Select the wanted Line key.
3. Press  and  or press  key to select the Key Event in the type field.
4. Press  and  or press  key to select the Paging.
5. Press  or Save soft key to save the configuration

To configure the Paging via Web interface

1. Click Function keys → Line key.
2. Select the desired Line key and select Paging in the Type.
3. Click the  to save the configuration.

DTMF

To configure the DTMF via Phone Interface

1. Press Menu→Features→Function Keys→Line Key as Function Keys
2. Select the wanted Line key.
3. Press  and  or press  key to select the DTMF in the type field.
4. Enter the value
5. Press  or Save soft key to save the configuration



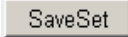

To configure the DTMF via Web interface

1. Click Function key → Line key.
2. Select the desired Line key and select DTMF in the Type.
3. Fill the value.

4. Click the  to save the configuration.

Prefix

To configure the Prefix via Phone Interface

1. Press Menu → Features → Function Keys → Line Key as Function Keys
2. Select the wanted Line key.
3. Press  and  or press  key to select the Prefix in the type field.
4. Enter the value
5. Press  or Save soft key to save the configuration

To configure the Prefix via Web interface

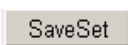
1. Click Function keys → Line key.
2. Select the desired Line key and select Prefix in the Type.
3. Fill the value.
4. Click the  to save the configuration.

Then when you press this key, the set value is input directly.

Upgrade

Factory Reset

To set Factory Reset by phone interface

1. Press Menu → Setting → Advanced Setting(default password: admin)→ Factory Reset
2. Press OK soft key in the warning page.

To set Factory Reset via web interface

Click Management → Upgrade

Click  and then confirm the setting.



The screenshot shows the web interface of a Hanlong Technology device. The top navigation bar includes Home, Account, Network, Function Keys, Setting, Directory, and Management (highlighted with a red box). The left sidebar contains Password, Upgrade (highlighted with a red box), Auto Provision, Configuration, TLS Certs, Restart, and Reboot. The main content area shows the Upgrade section with a 'Reset To Factory' button (highlighted with a red box). The 'Image Version' section displays Major Version: IMG--1.0.3.59(2013-12-06 18:26:00) and Minor Version: IMG--1.0.3.59(2013-11-30 17:40:00). The 'Pcap Feature' section has Start, Stop, and Export buttons. The 'Img Firmware Upgrade' section has a '选择文件' button and an 'Upgrade' button. A 'NOTE' section on the right provides information about the image version and the 'Reset To Factory' action.

Upgrade

To upgrade software, this phone can be configured with a TFTP server where the new code image is located. The TFTP upgrade can work in either static IP or DHCP mode using private or public IP address. It is recommended to set the TFTP server address in either a public IP address or on the same LAN with the phone.

To configure the TFTP server via the Web configuration interface

Input the admin password to enter the configuration screen. From there, enter the TFTP server address in the designated field towards the bottom of the configuration screen.

Once the TFTP server is configured, please power cycle the phone.

TFTP process may take as long as 1 to 2 minutes over the Internet or just 20+ seconds if it is performed on a LAN. Users are recommended to conduct TFTP upgrade in a controlled LAN environment if possible. For those who do not have a local TFTP server, Hanlong provides a NAT-friendly TFTP server on the public Internet for firmware upgrade. Please check the Service section of Hanlong’s Web site to obtain this TFTP server’s IP address.

Directory to configure local TFTP

1. Unzip the file and put all of them under the root directory of the TFTP server.
2. The PC running the TFTP server and the UC IP PHONE should be in the same LAN segment.
3. Go to File -> Configure -> Security to change the TFTP server's default setting from "Receive Only" to "Transmit Only" for the firmware upgrade.
4. Start the TFTP server, in the UC IP PHONE’s web configuration page.
5. Configure the Firmware Server Path with the IP address of the PC.
6. Update the change and reboot the unit.

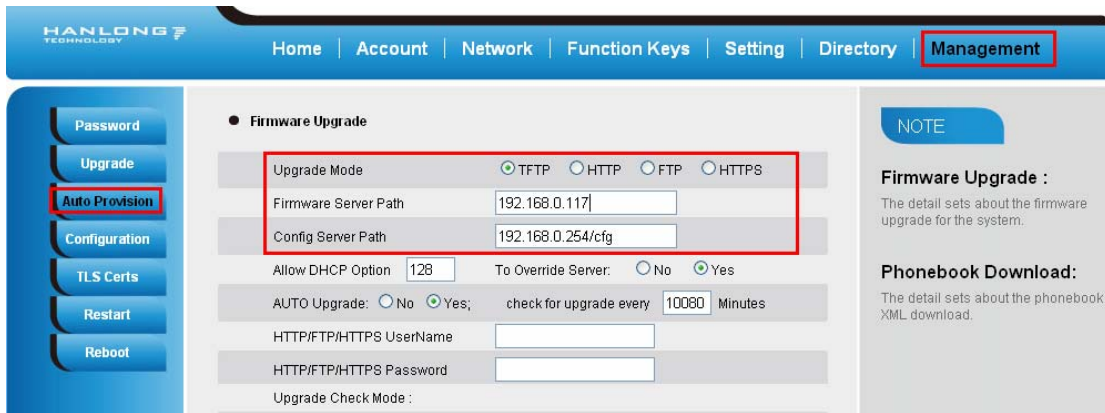

NOTES:

When Hanlong IP Phone boot up, it will send TFTP or HTTP request to download configuration files, there are two configuration files, one is “cfg.txt” and the other is “cfg001fc1xxxxxx”, where “001fc1xxxxxx” is the MAC address of the phone. These two files are for initial automatically provisioning purpose only, for normal TFTP or HTTP firmware upgrade, the following error messages in a TFTP or HTTP server log can be ignored.

Download and install a free TFTP or HTTP server to the LAN to perform firmware upgrades. A free Windows version TFTP server is available:

http://www.solarwinds.com/products/freetools/free_tftp_server.aspx.

To upgrade manually via the Web configuration interface

Download the firmware.

Click Management → Upgrade

Click Brower or the blank.

Select the firmware and then click .

Restart.

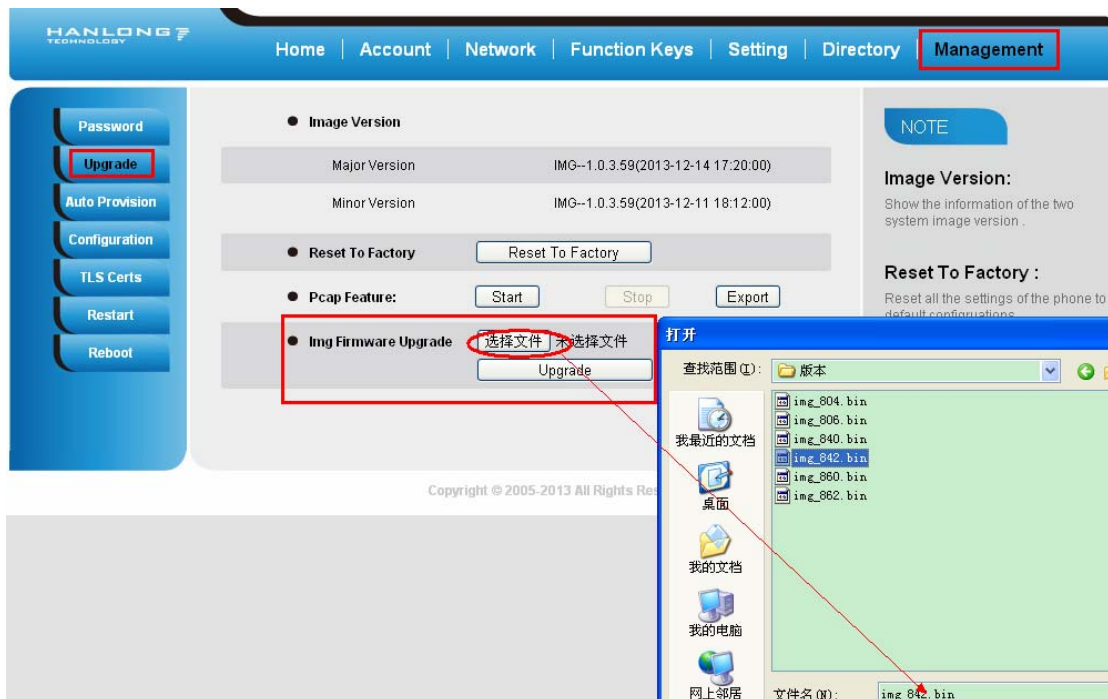

Troubleshooting

Why is the phone LCD screen blank?

1. Ensure your phone is properly plugged into a functional AC outlet.
2. Ensure that the phone isn't plugged into a plug controlled by a switch that is off.
3. If the phone is plugged into a power strip, try plugging it directly into a wall outlet instead.
4. If your phone is powered from PoE, ensure you use a PoE compliant switch or hub, or contact your system administrator for more information.
5. Check that the power LED is on to ensure the phone is powered on.

Why does the phone display "Network Unavailable"?

- Ensure that the Ethernet cable is plugged into the Internet port on the phone and the Ethernet cable is not loose.
- Ensure that the switch or hub in your network is operational.
- Contact your system administrator for more information.

Why can't I get a dial tone?

- Check for any loose connections and that the phone has been installed properly. For the Installation instructions, refer to [Phone Installation](#).
- Check whether dial tone is present on one of the audio modes.
- Switch between the Handset, Headset (if present) or Hands-Free Speakerphone to check whether dial tone is present for one of the audio modes.
- If the dial tone exists on another audio mode, connect a different handset or headset to isolate the problem.